

(Interconnect PCB)

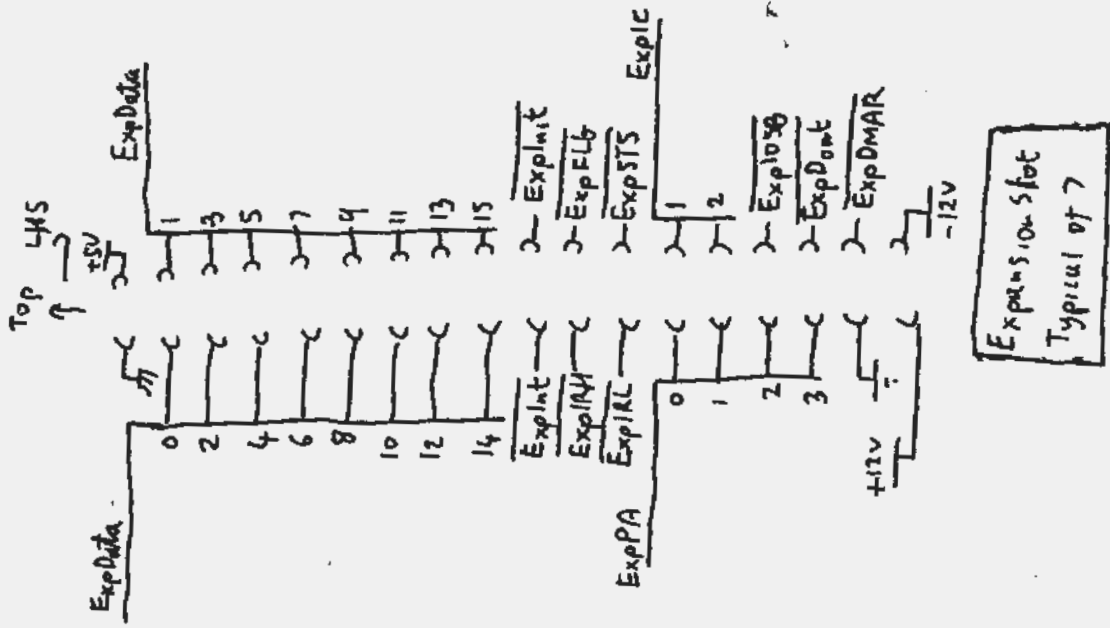

Expansion slot
Typical of 7

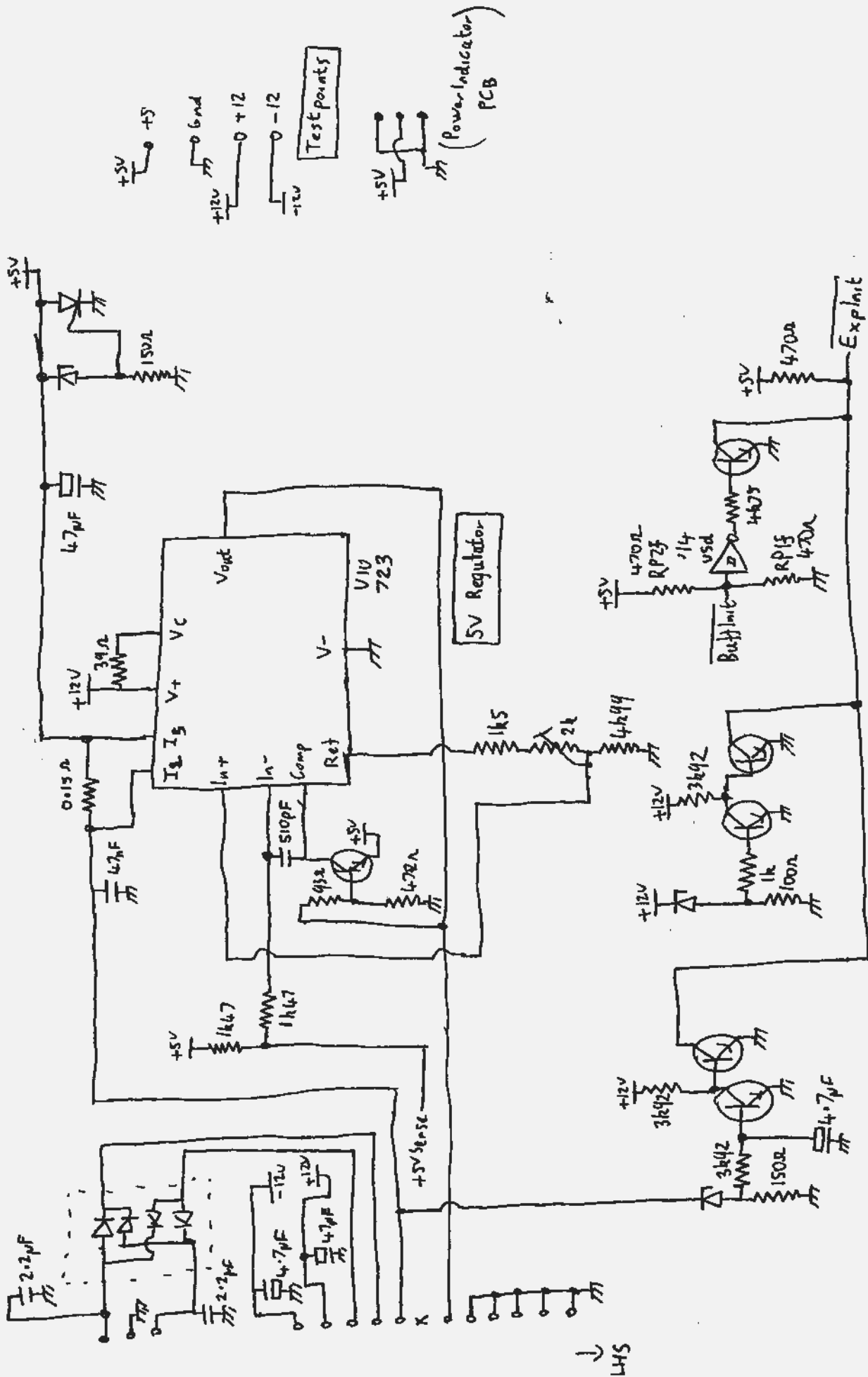

09878-66502

HP 9878 Control PCB Sheet ①

↓ LHS

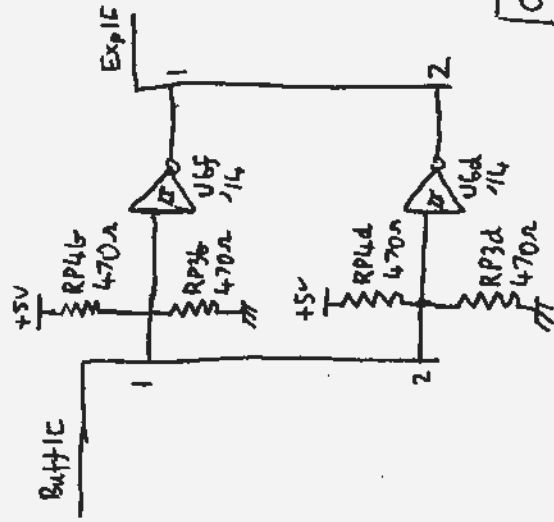
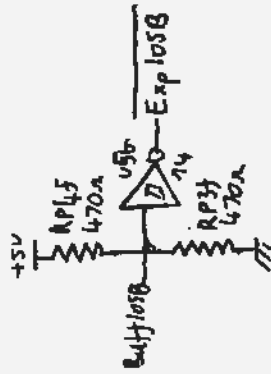
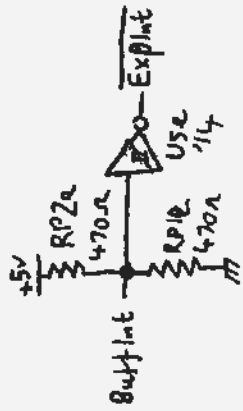
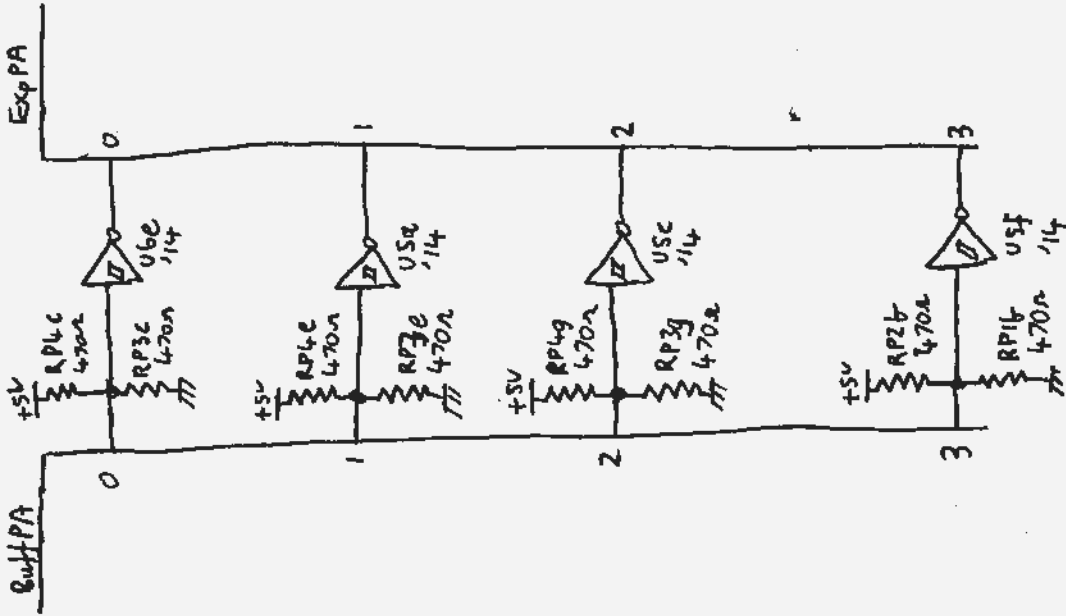

Output Buffers

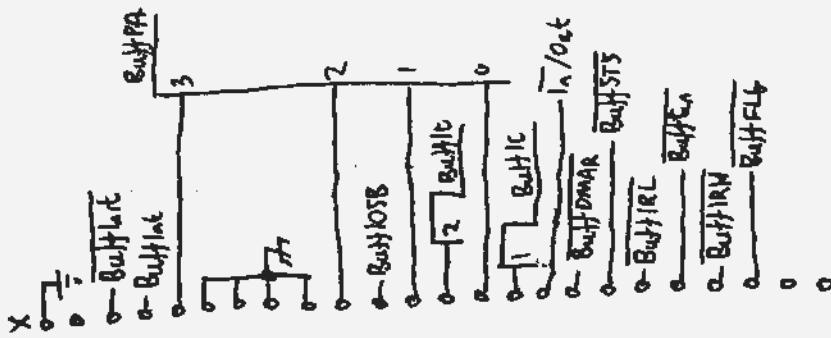

Buffer/Data

Data Bus Termination

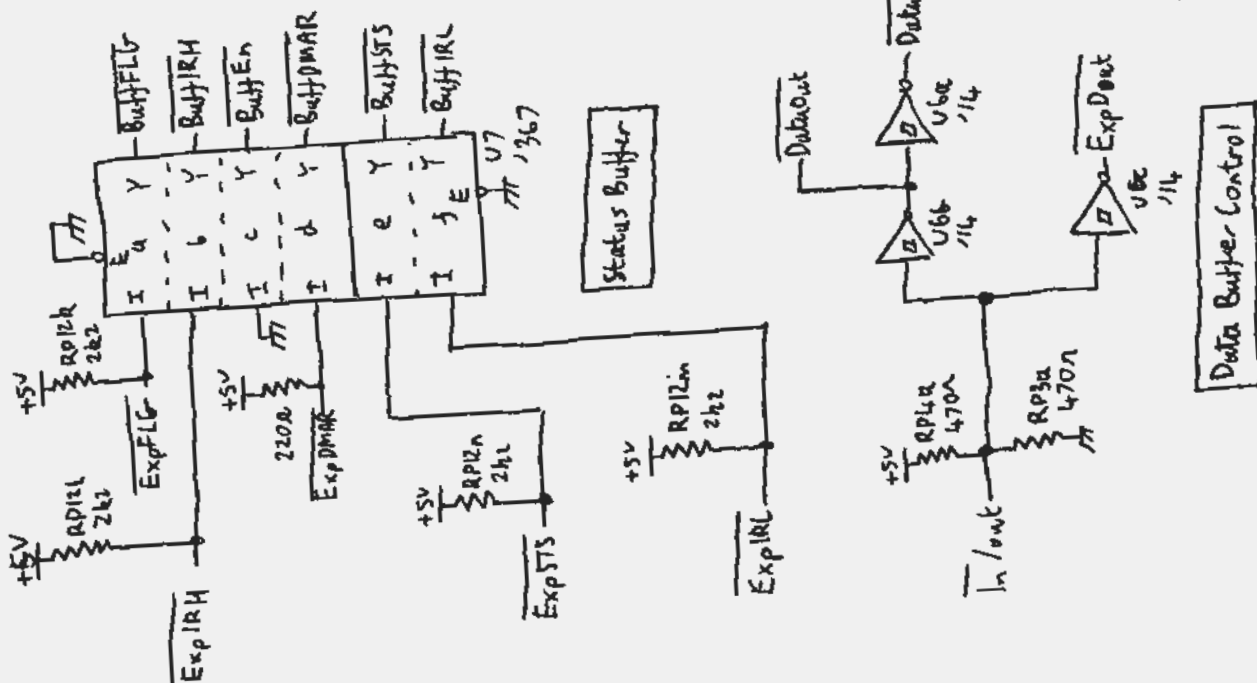
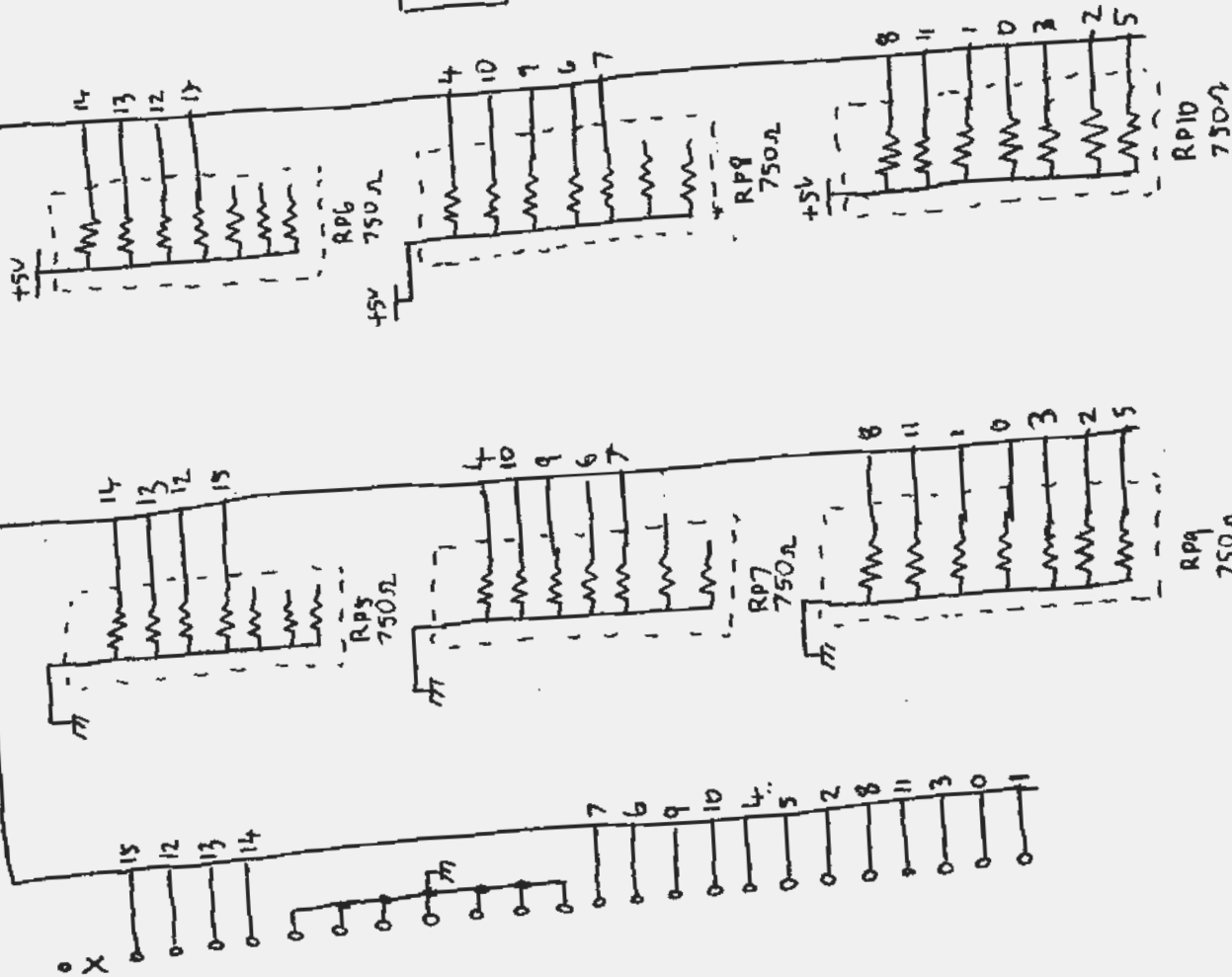

09878-66502

Sheet 3

HP 9878 Control PCB

Top
New

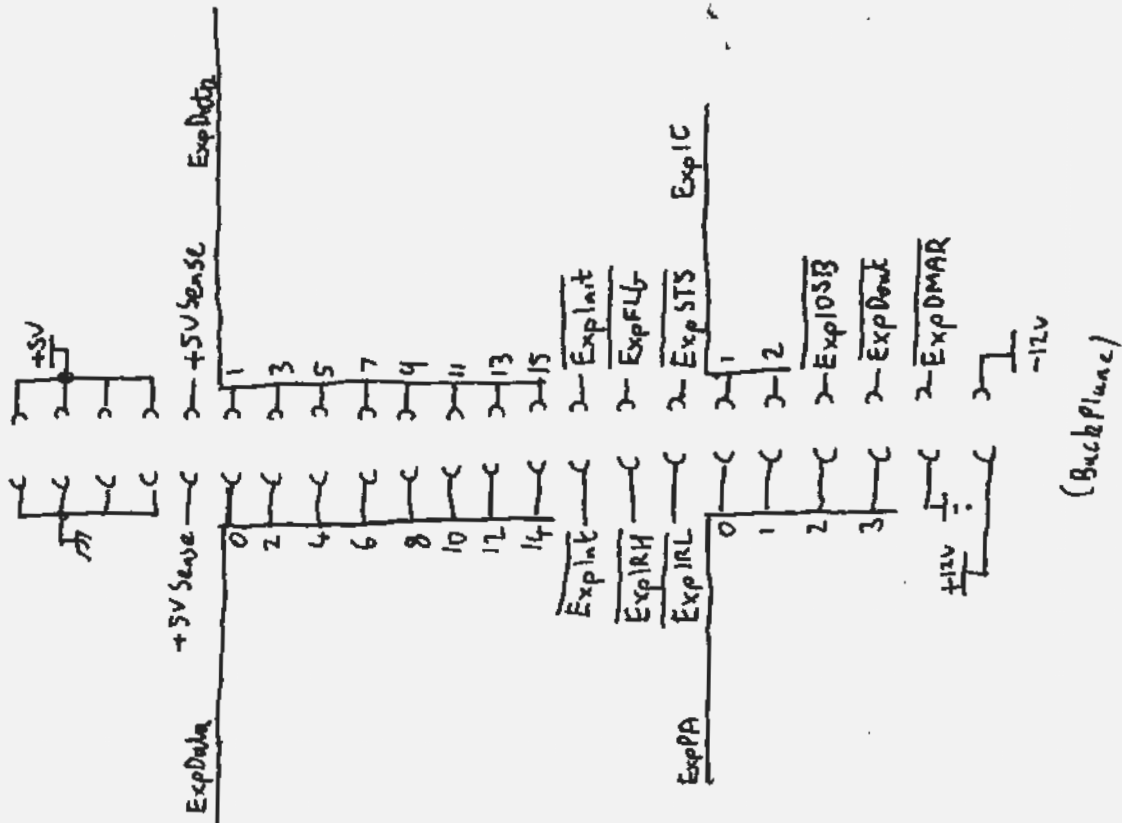
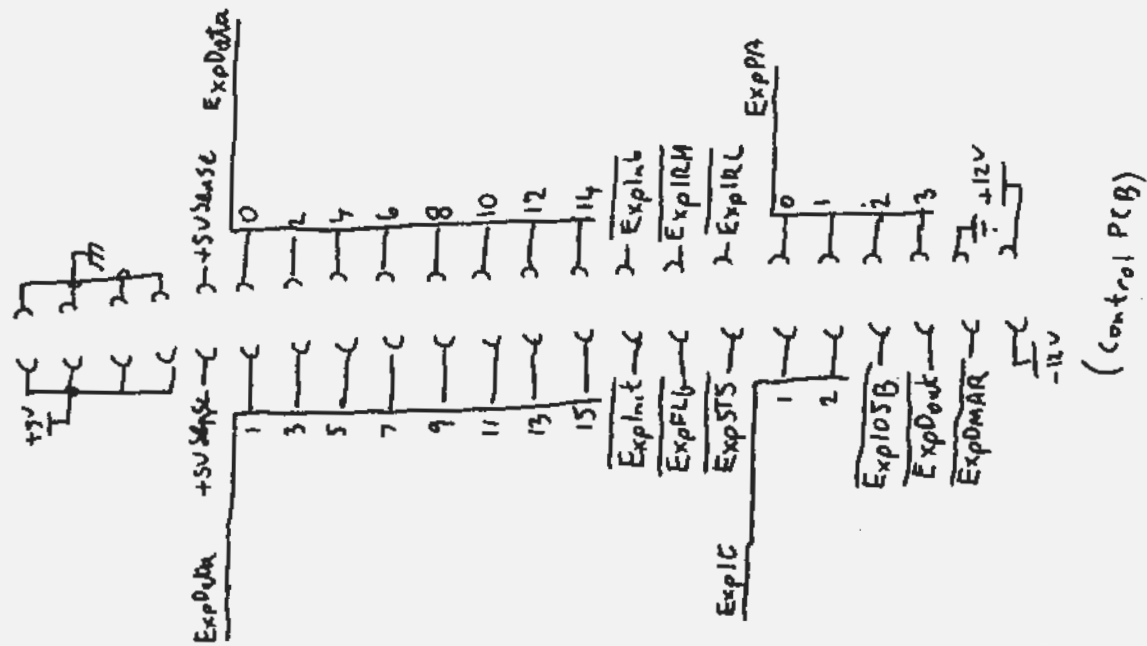

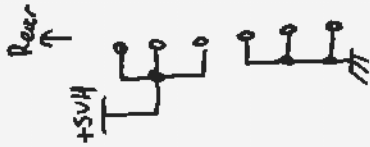
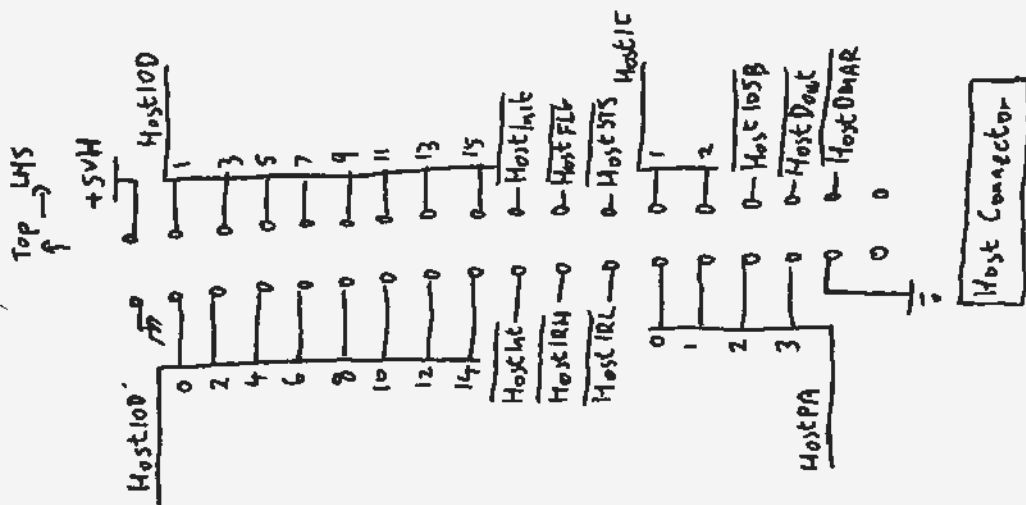

Host Control Buffer Pins

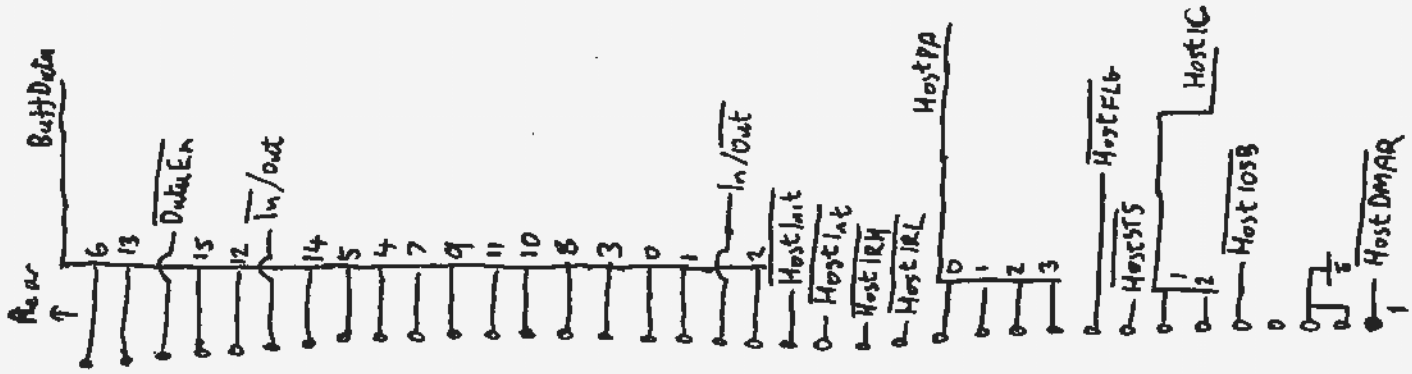

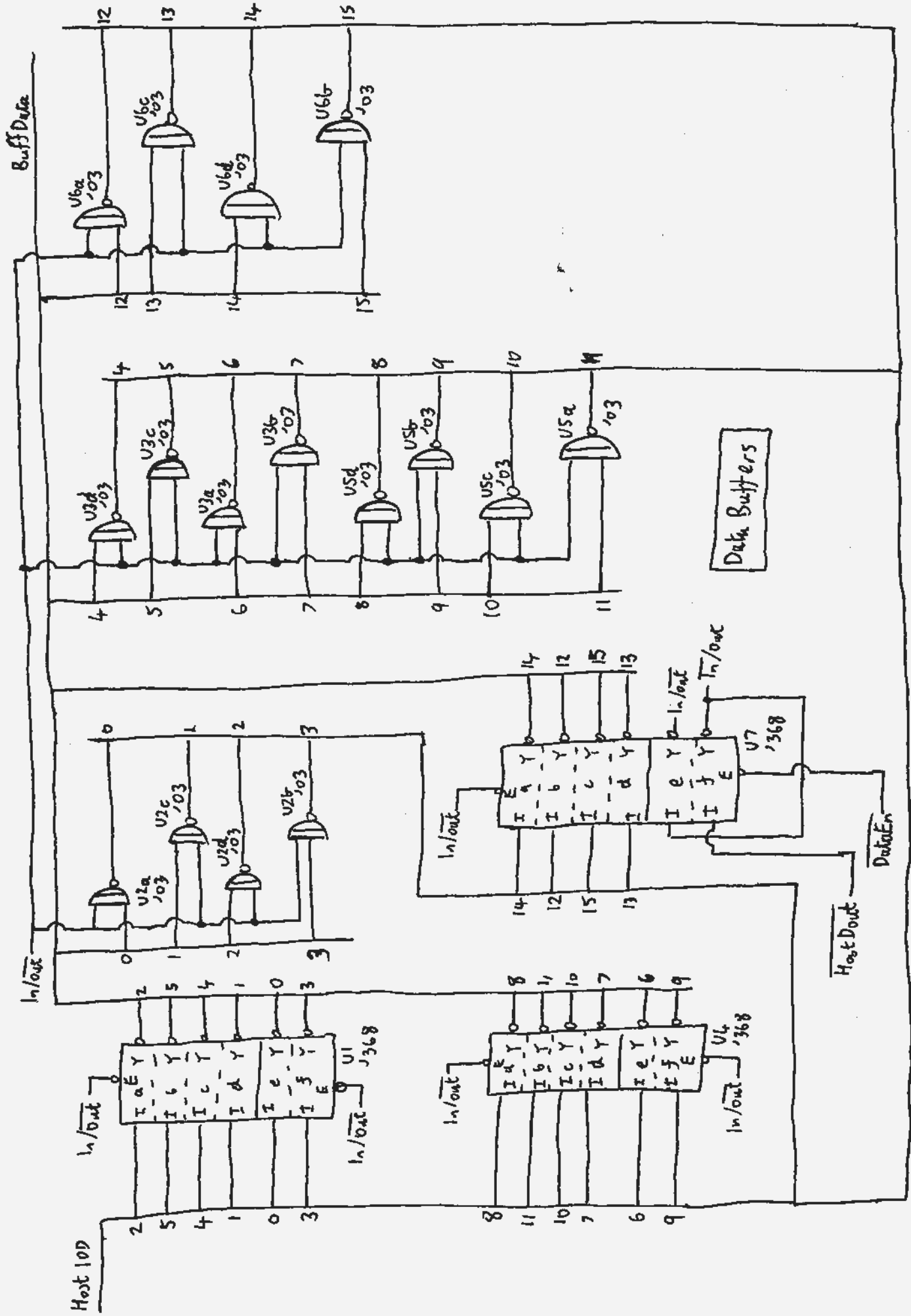

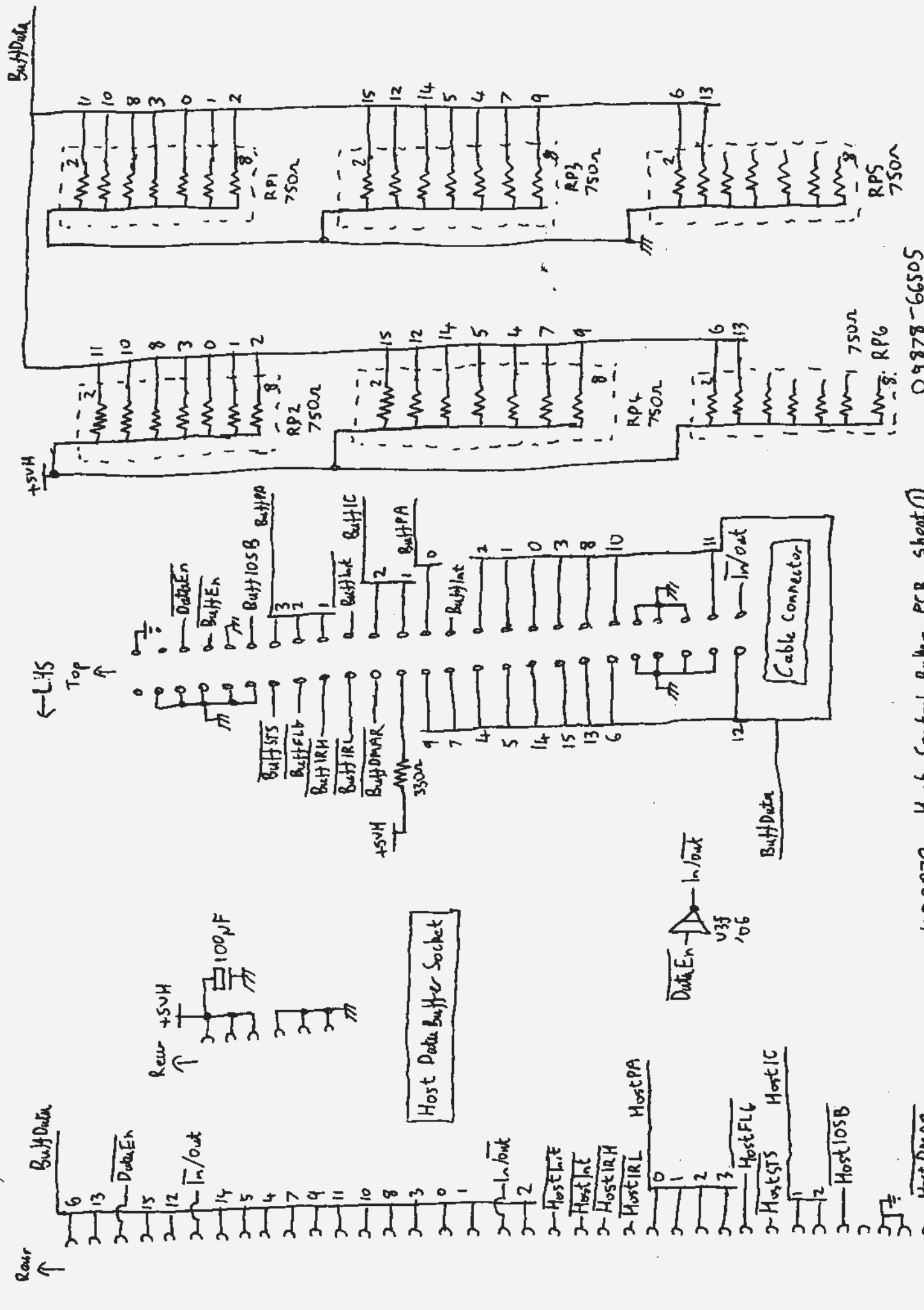

HP 9878 Host Control Buffer PCB sheet ① 09878-66505

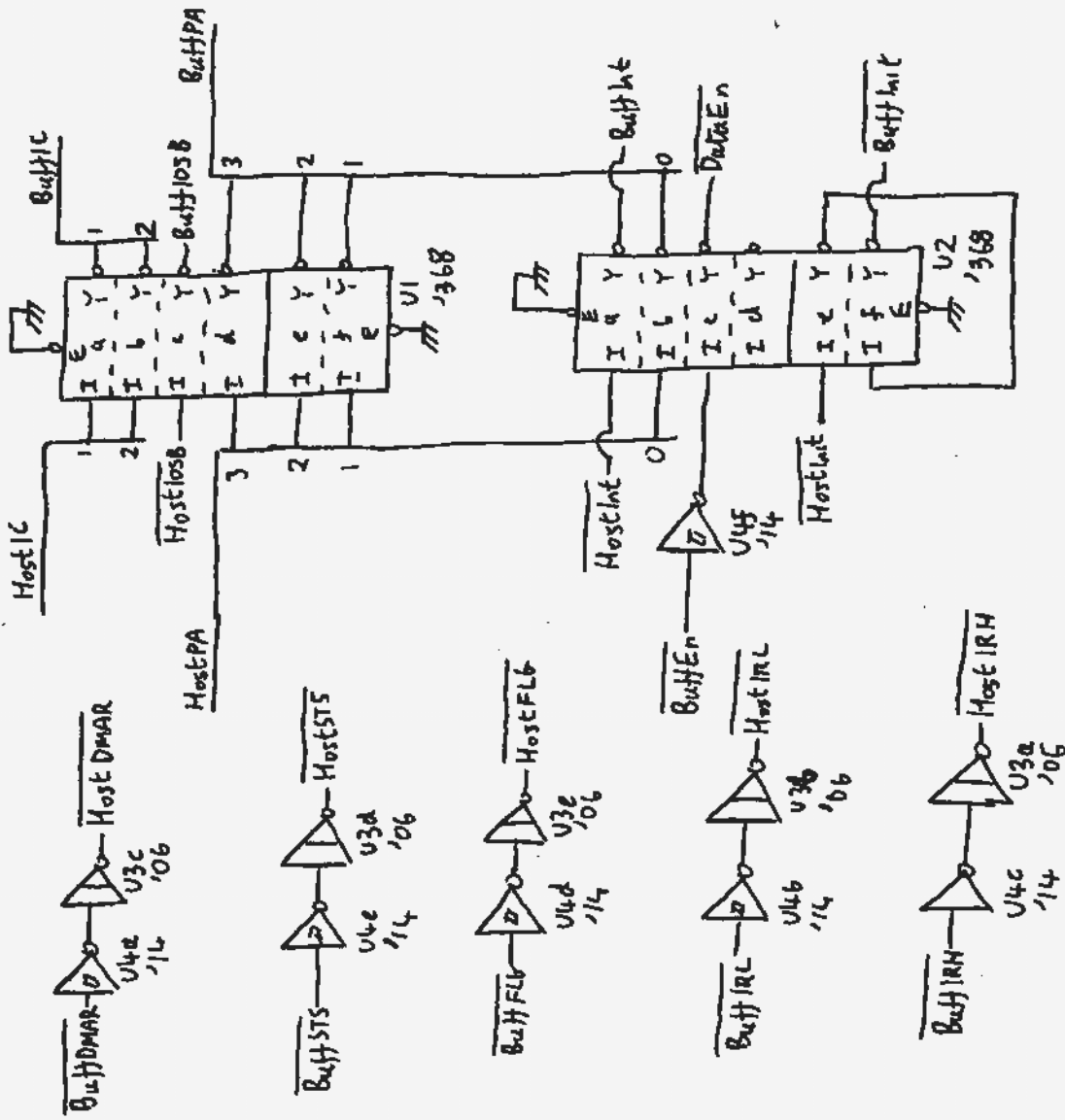

Control Buffers

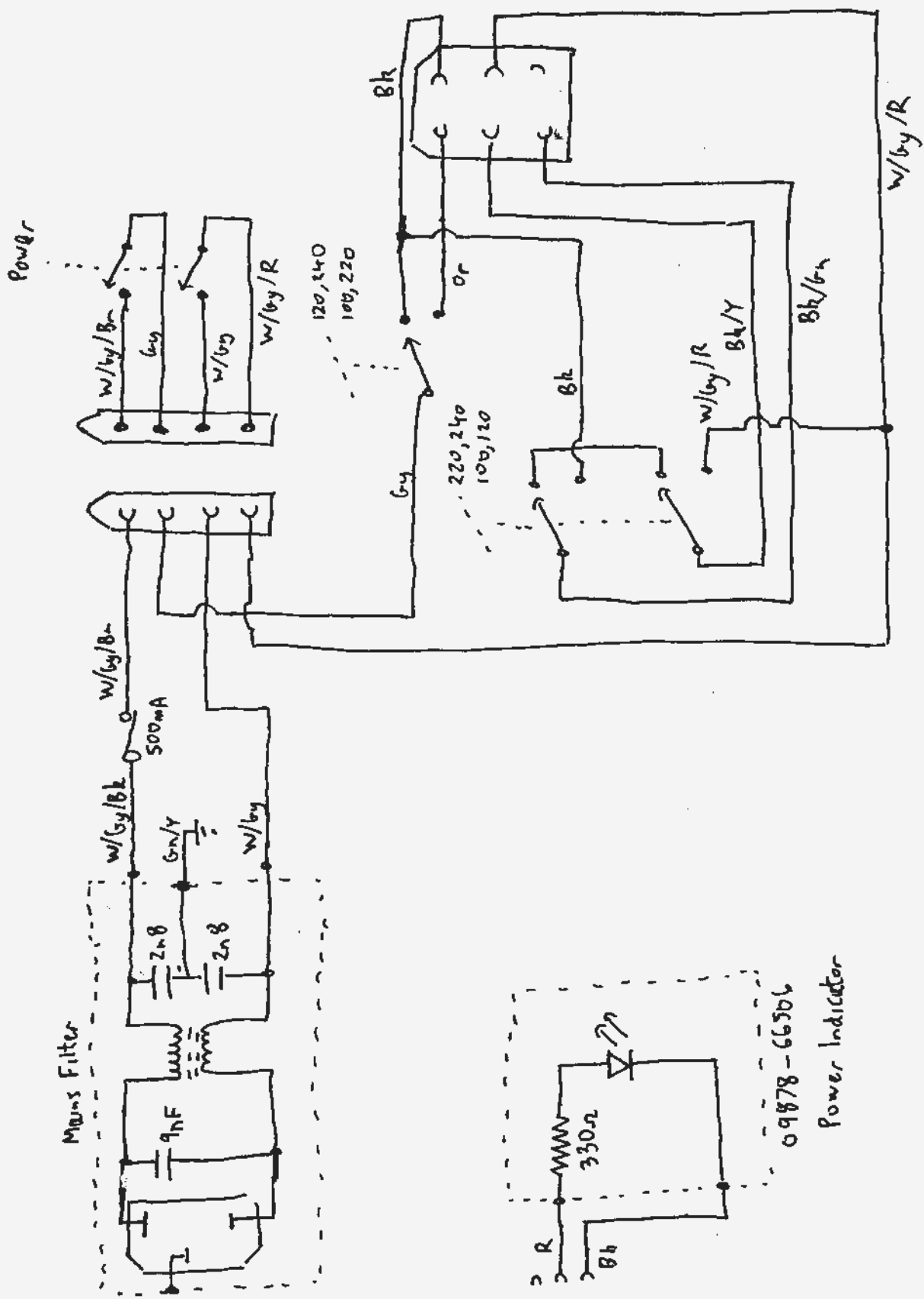

HP9878 Power Wiring

